



# LED ILLUMINATION



***AUTOMATION***

# About

Metaphase Technologies offers the world's largest selection of machine vision and specialty LED Illumination. Since 1993, our engineering expertise in designing for integration into vision systems has enhanced a vast array of products. Metaphase illumination for industrial applications such as automation systems, line scan inspection, and fast-capture imaging strobe gives an edge to our customers in manufacturing and quality assurance. Most recently we've expanded our scope to develop illumination for security applications such as border patrol, law enforcement, and military markets.

Our award winning innovation has been recognized by The White House, our peers, and local business associations. We offer free testing and encourage you to bring your most challenging applications for a custom solution today. We stand by our credo, Lighting Excellence Delivered for customer Satisfaction!



**HYPERSPECTRAL**  
LED ILLUMINATION SYSTEM

**SWIR**  
LED ILLUMINATION

**METAPHASE**  
LIGHTING TECHNOLOGIES

211 Sinclair Road Suite 100, Bristol, PA 19007 USA

Tel: 215-639-8699 • Fax: 215-639-0977

[www.metaphase-tech.com](http://www.metaphase-tech.com)

## METAPHASE TECHNOLOGIES

600kHz FASTRIG • Stereo Illumination • 360 Coaxial Light • Polarization  
*See Pages 1-2*

## INNOVATIVE PRODUCTS

Multispectral • Hyperspectral • SWIR • Barcode  
*See Pages 3-6*

## LINE LIGHTS

UL • MetaBright • MetaLight • Collimated • Compact Diffused Tube • Diffused Axial  
Oblique • Dark Field  
*See Pages 7-12*

## AREA SCAN

Exolight • Dome • Flat Dome • Tube • Co-Axial Dome • Axial • Ring  
Off Axis Ring • Washdown/Harsh Environment • Backlights  
*See Pages 13-22*

## LED LIGHT ENGINES

Metaphaser • Microscope Illumination  
*See Pages 23*

## CONTROLLERS & DRIVERS

ULC-2 • DDC-3 • LC2-PWM20  
*See Pages 24*

## STROBE LIGHTS

Long Range • Law Enforcement • Border Patrol  
*See Pages 25*

## PROJECTION LIGHTS

Spot Light • Pattern Projector.  
*See Pages 26*

# METAPHASE TECHNOLOGIES

## 600kHz FASTRIG

Metaphase's 600kHz FASTRIG is the highest rate driver in the industry. By partnering with leading line scan camera manufacturers, our illuminators can be synchronized with the industry's fastest line scan cameras. The FASTRIG driver allows high speed switching between either multiple wavelengths or illumination techniques at rates high enough to capture synchronized images on a scan line by scan line basis. Typical applications of high-speed line scan multiplexing include combinations of front and back lighting or alternating between different wavelengths, like infrared and visible.

### HIGH SPEED MULTIPLEXING

## 600kHz



### MULTIPLEXING

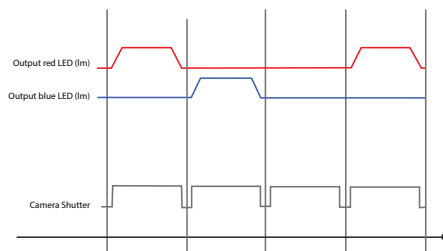

### RGB MULTIPLEXING

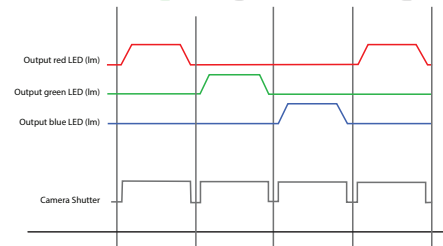

## STEREO ILLUMINATION

Metaphase's Stereo Illumination provides segmented illumination stereo or shape-from-shading vision systems. By taking multiple sequential exposures with lighting with directional light from different segments, these multiple images can be stitched together to create an enhanced image with improved contrast of surface features. This is great for objects with surface defects such as wrinkles, punctures, chips and tears as well as identifying embossed or stamped codes and text. We offer the largest selection of segmented stereo illuminators big and small to fit your application.



Dome Light



Ring Light



# METAPHASE TECHNOLOGIES

## 360 Coaxial Light

The 360 coaxial light is the newest light in the Metaphase product portfolio and is an industry first light that provides even illumination around reflective cylinders. The light utilizes a conical beamsplitter to provide the same on-axis lighting found in our diffuse axial lights. The conical properties of the beam splitter allow 360° of on axis illumination, which can be paired with multiple line scan and area scan cameras to provide a full 360° inspection of extruded parts.



## POLARIZATION

With the recent launch of Teledyne Dalsa and Sony's polarized cameras, polarization is quickly becoming the new hot trend in machine vision and Metaphase has been expanding our portfolio of polarized lighting to meet the demand. While traditional polarization with lens filters and lights filters still work, it will become a thing of the past. With properly polarized light, you can get the best cross polarization possible with polarized cameras to minimize glare. We offer a range of polarized lights in both area scan and line scan to meet all machine vision illumination needs.

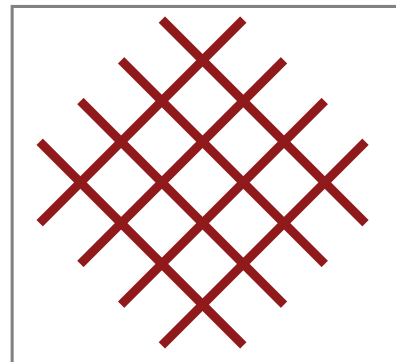

**Non-Polarized Imager & Non-Polarized Light**



**BAD**

**Polarized Imager & Non-Polarized Light**



**OK**

**Polarized Imager & Cross Polarized Light**



 **GREAT**

# MULTISPECTRAL ILLUMINATION

Metaphase is proud to introduce our next generation of breakthrough LED illumination for the machine vision market with the latest addition to our family of Multispectral LED lights, the RGB + IR LED Line Light. Traditionally multispectral line scan inspection applications, such as agriculture (fruit, meat, etc.) inspection, required multiple inspection stations, each with its own camera and unique single wavelength (color) LED light. Multispectral cameras from companies such as Teledyne Dalsa and JAI, along with these Metaphase line lights configured with individually controllable RGB & IR LEDs can perform all these inspections at a single station. With discrete R, G, B, and IR LEDs you can maximize contrast by choosing the best color and provide more intensity in a specific wavelength compared to a traditional monochrome line light. Multispectral wavelengths are not limited to just RGBIR but also include UV and Short Wave infrared (SWIR). See partial list of wavelengths below.

## Available Wavelengths



## SWIR Wavelengths

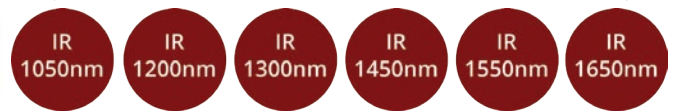

### Multispectral Line light



Image A: Color Image B: Monochrome Image C: IR

### Multispectral Area Scan

We are also bringing our Multispectral technology to area scan. With products like our Multispectral Exolight v2.0 and Backlights, you too can maximize contrast by choosing the best color and provide more intensity in specific wavelength compared to a traditional monochrome light.

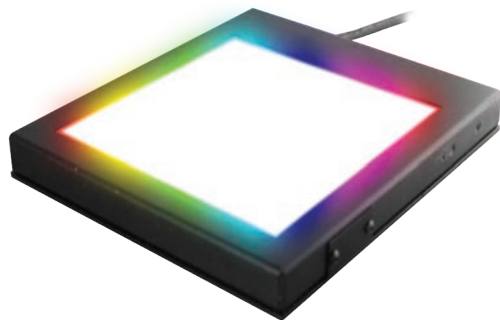

### Applications:

- Machine Vision & Automation
- Packaging inspection such as absence & presence of product
- Work bench illumination
- Automotive component inspection
- Coiled steel pin-hole detection
- Pick & place
- Sorting facilities / Bar code reading
- Robotic Inspection



# HYPER SPECTRAL

## LED ILLUMINATION SYSTEM

Metaphase has another machine vision first, Hyperspectral broad band LED illumination! Finally break away from the typical hyperspectral Halogen light source with its high temperature and high power consumption. Metaphase Hyperspectral 400nm-NIR and Broadband SWIR illumination (1000-1700nm) provides the ideal match to your favorite Hyperspectral camera. Don't need the full spectrum? Metaphase can tailor the light sources to match the camera's spectral response and specific application requirements.

### PushBroom HSI Spectral Curves

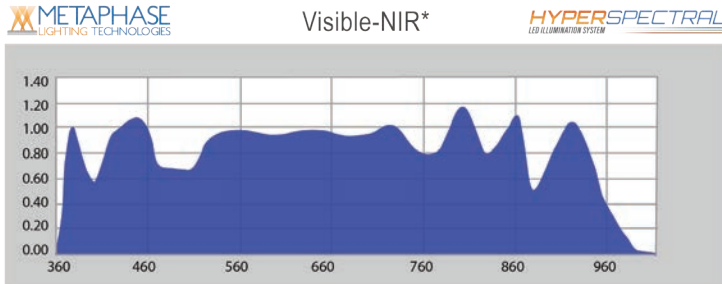
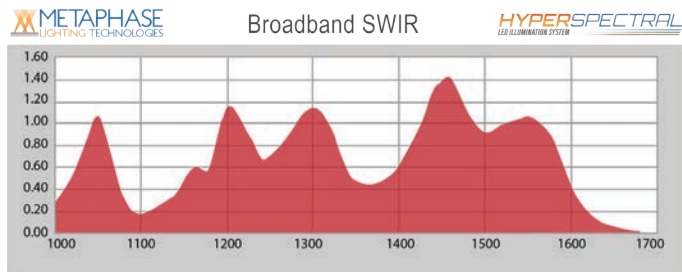

### SnapShot Mosaic/Tile Area Scan HSI Spectral Curves

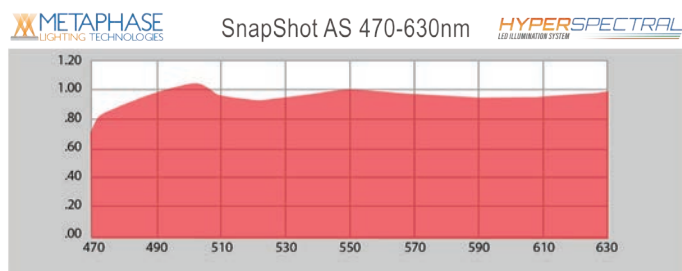

\*Provisional

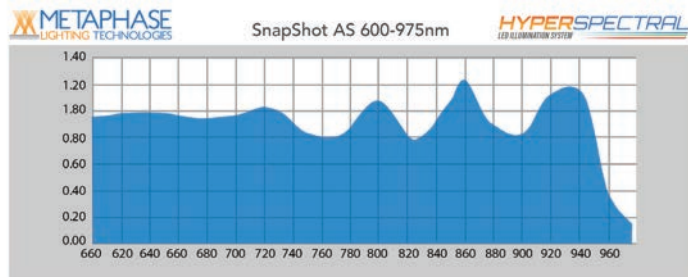

\*Provisional

# LINE LIGHT



VisionSystems  
DESIGN  
2018 **Innovators Awards**



### Applications:

- Color Chemical Analysis
- Sorting
- Food
- Pharmaceutical
- Machine Vision & Automation
- Robotic Inspection

### Camera Examples:

- SPECIM
- RESONON
- PHOTON FOCUS
- XIMEA

Metaphase Hyperspectral LED Lights can be optimized to match your Camera's hyperspectral response and/or specific application spectral requirements.

Please contact your Metaphase representative for details.



# SWIR LED ILLUMINATION

Visible, IR, UV, Multispectral and now SWIR. Metaphase continues to lead the machine vision LED illumination market with innovative products that utilize the latest in LED technology. SWIR, typically defined to be wavelengths included in the 900nm to 2500nm wavelength range, is another tool that can be used to find defects in objects where typical UV, Visible and IR illumination do not provide the necessary contrast. Like visible light, different materials will absorb and reflect SWIR. Applications include inspection of fruit (bruising), solar cell & semiconductor wafer inspection, anti-counterfeiting, leak detection, presence of coatings, fill level, moisture presence, etc. SWIR LED illumination is available for both line and area scan.

## Available Wavelengths

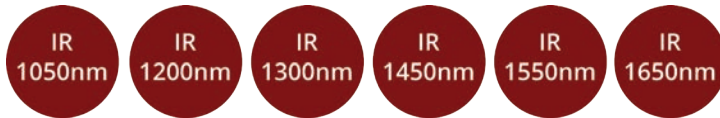

VISIBLE

SWIR



VISIBLE

SWIR

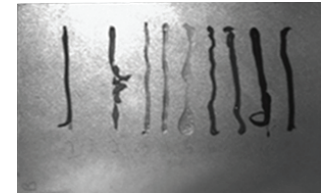
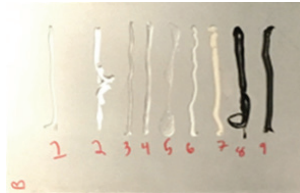

Courtesy of Princeton Infrared®

VISIBLE

SWIR

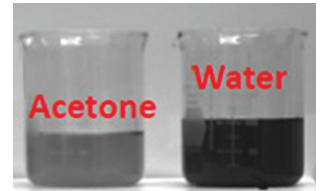
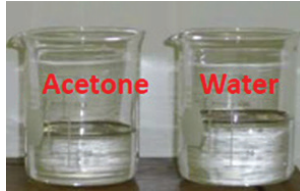

Courtesy of Princeton Infrared®

VISIBLE

SWIR

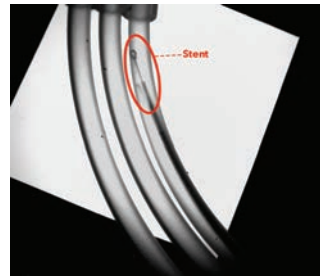
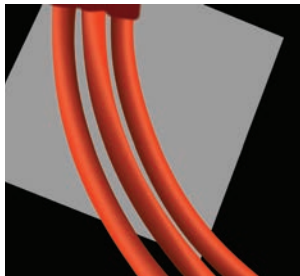

### Applications:

- Color Chemical Analysis
- Pharmaceutical
- Sorting
- Machine Vision & Automation
- Food
- Robotic Inspection

VisionSystems DESIGN  
2018 Innovators Awards







# High intensity illuminator for all the popular image based 1D/2D/OCR ID readers.

For applications that require higher intensity and/or larger coverage area, Metaphase has developed a High intensity illuminator that mounts & interfaces directly to all the popular readers including, but not limited to Keyence, Cognex, Sick and Dalsa readers. By simply configuring the light with the appropriate mounting plate, it can be mounted directly to your image based reader of choice. The light can be used in continuous or strobe mode and provides illumination intensity for maximum read rates. These illuminators can be configured with the LED color/lensing/diffuser/polarizing required to provide a homogeneous, high intensity, non-glare image to maximize code-to-background contrast. Metaphase family of Barcode/OCR reader lights include 7 inch (178mm) and 14 inch (356mm) versions.

## Available Wavelengths



### KEYENCE EDITION



14 inch (356mm) Version

### TELEDYNE DALSA BOA SPOT EDITION



7 inch (178mm) Version

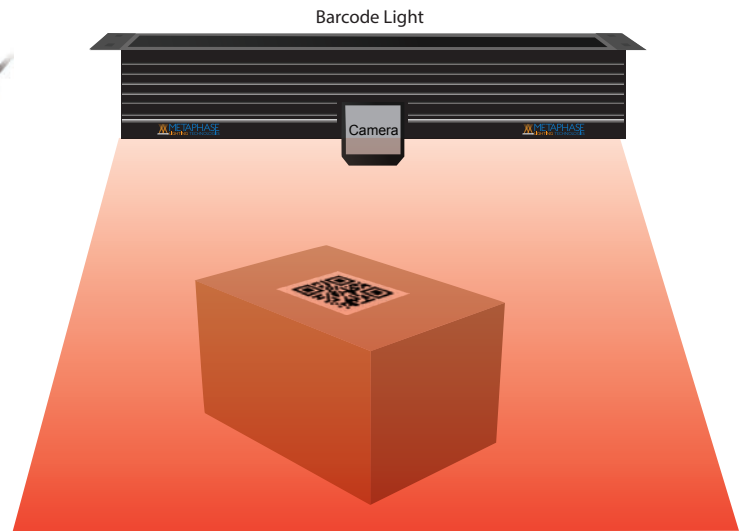

QR Code Captured

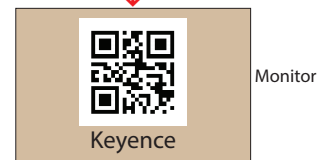

Embedded Text Read Out

### Applications:

- 1D/2D/OCR Barcode
- Logistics

### Camera Examples:

- Keyence
- Teledyne Dalsa
- Cognex
- Sensopart
- Datalogic
- Sick
- Matrox
- Microscan

# LINE LIGHTS FOR LINE SCAN



## NEW INNOVATIONS HIGHER QUALITY UNIFORMITY

### **Why Line Lights?**

#### **Front and Back Line Lights**

Traditional line lights like the Metaphase UL and MetaBright series are the preferred illumination for line scan applications. The narrow, structured beam delivers high intensity and concentrated light for the narrow field of view of a traditional line scan camera. Intensity and uniformity are vital to producing proper part illumination. Most line scan applications are high-speed with low exposure times and insufficient light levels prevent the camera from acquiring a usable image.

#### **Visible Light and the Power of RGB Control**

As with conventional vision systems, the color of light provided by the line scan illumination system can have a significant impact on image contrast and rendering. 6000K (degrees Kelvin) visible white light, currently the most popular choice, is neutral and great for enhancing product detail. A close second is the warmer 3000K, suitable for applications requiring high color rendering index (CRI) for accurate color rendering and accuracy. Although visible white light is popular and flexible, the use of specific wavelengths (colors) can often improve contrast and feature extraction. For example, the use of red (620-750nm) light enhances blue text (the complement of red) on an object, enhancing the contrast and making the text more readable. This technique is frequently used in the printing and packaging industries. Metaphase manufactures variable RGB line lights, whose output can be quickly and easily changed from any of its individual components (Red, Green, Blue).

#### **Nonvisible, Near IR Lighting**

Near IR illumination has garnered significant popularity with the increased use of security cameras. Near IR illumination produces very high apparent brightness at lower power levels across significant distances. This technology has been adopted for line scan applications. Reasons to use near IR include, the invisibility (to humans) of near IR wavelengths (850nm, 880nm, 940 nm), and that the camera sensor chips have reasonable sensitivity in this range. Note that silicon, hence most types of glass, is invisible to near IR. So, special lenses must be employed to properly focus the light onto the camera sensor. Some inks are also rendered invisible to near IR. Because near IR utilizes a single wavelength, it is intensity-based (rather than color-based). Thus, near IR is particularly useful when color variations need to be ignored on web applications, such as printing and rolling metal stock.

#### **UV Lighting**

UV (365nm, 395nm) has seen huge strides and very large up ticks in market penetration over the last few years. High intensity and tight focusing of the line scan illumination optimize the output of the UV LEDs. This illumination then excites UV-sensitive material or is absorbed, releasing visible light, often either blue or green depending on the material and excitation wavelength.

# THE BEST KEEPS GETTING BETTER

## UL Line Light

Blending the advanced breakthrough technology of our Gen4 Line Light with the compact design of our MetaBright™ Line Light, the UL Line Light is the latest line light design in the Metaphase family. Its narrow, structured beam delivers high intensity and concentrated light for the narrow field of view of a traditional line scan camera. The high intensity and uniformity allows the UL Line Light to be used as a front light to inspect for material defects, angled to obtain an off-axis effect to highlight surface defects, or it may be placed beneath the object for a backlight effect to inspect for holes, voids, or contaminants. The UL Line Light is available with a wide variety of LED colors such as white, red, green, blue, IR, UV (365nm & 395nm), and RGB with independent color control up to 120" (348m) in length for large web applications.

### Applications:

- Web inspection (foil, plastic film, PCBs, glass, paper, web converting, etc.)
- Geometry measurements of long targets
- Direct position measurement
- Printed circuit board inspection
- Tube or bottle inspection
- Machine Vision & Automation
- Robotic Inspection



# LINE LIGHTS

## MetaBright™ Line Lights

Our classic MetaBright line light utilizes active fans for cooling to deliver intense and uniform lighting while keeping a tight thermal profile. Metaphase offers the industry's breakthrough performance line lights for imaging, web, and high-speed line scan applications requiring ultra-high intensity and uniformity. Our line lights are built as lean fixtures that can be easily controlled and integrated into vision systems. Our MetaBright™ Line Lights feature an adjustable lens and low current consumption. The MetaBright™ Line Light is available with a wide variety of LED colors such as White, Red, Green, Blue, IR, UV (365nm & 395nm), and even RGB with independent color control up to 120" (3m) in length for large web applications.

### Applications:

- Web Inspection (Foil, Plastic Film, PCBs, glass, paper, web converting, etc)
- Geometric measurements of long targets
- Direct Position measurement
- Printed circuit board inspection
- Tube or bottle inspection
- Quality control in food, chemicals and textile industry
- Detection of holes in highly transparent films (Backlighting) and laminated glass



- Nonwovens
- Fabrics
- Solar Cells
- Hot Steel Inspection
- Long Working distance applications such as tunnel, rail, or ceiling inspection
- High precision, High accuracy measurement applications
- Machine Vision & Automation
- Robotic Inspection

## MetaLight™ Line Lights

MetaLight™ line lights are for applications that require a narrow strip of light at lower intensities than the MetaBright line lights. Thousands of these lights are currently being used in applications across the globe. The MetaLight™ Line Light is available with a wide variety of LED colors such as White, Red, Green, Blue and IR and in sizes up to 80" (2m) for large web applications.

### Applications:

- Web Inspection (Foil, Plastic Film, PCBs, glass, paper, web converting, etc)
- Geometric measurements of long targets
- Direct Position measurement
- Printed circuit board inspection
- Tube or bottle inspection
- Quality control in food, chemicals and textile industry
- Detection of holes in highly transparent films (Backlighting) and laminated glass



- Nonwovens
- Fabrics
- Solar Cells
- Hot Steel Inspection
- Long Working distance applications such as tunnel, rail, or ceiling inspection
- High precision, High accuracy measurement applications
- Machine Vision & Automation
- Robotic Inspection



# HIGH UNIFORMITY HIGH INTENSITY

## Collimated Line Lights

Using Metaphase's propriety optics, the Collimated Line Light works similar to a traditional line light but can project its light at a lower divergence angle. This helps keep a tight, structured beam of light at longer working distance many meters away while delivering high intensity. This works great for applications where you can't have the light close to the object or web. This is useful creating clearance for robotics, imaging high tunnel ceilings (see image at right), create distance from hot objects, or applications requiring extremely precise backlight imaging. The Collimated Line Light is a great tool for any line scan or machine vision lighting application. The Collimated Line Light is available with a wide variety of LED colors such as White, Red, Green, Blue, IR, UV (365nm & 395nm), and RGB with independent color control up to 150" (3.81m) in length for large web applications.

### Applications:

- Web Inspection (Foil, Plastic Film, PCBs, glass, paper, web converting, etc)
- Geometric measurements of long targets
- Direct Position measurement
- Printed circuit board inspection
- Tube or bottle inspection
- Quality control in food, chemicals and textile industry
- Detection of holes in highly transparent films (Backlighting) and laminated glass

## Liquid & Compressed Air Cooled Line Light

Utilizing liquid cooling and compressed air, Metaphase can break down the thermal barriers of high end line scan applications. The additional cooling allows us to push our line scan illumination to the extreme. Whether it's to provide a lighting solution in a high ambient environment or pushing the envelope of extreme performance and intensity, our Metaphase liquid & compressed air cooled lights are an industry leader!

- High ambience
- Extreme intensity



Liquid Cooled UG Line Light

MB-Collimated Line Light



UX-Collimated Line Light

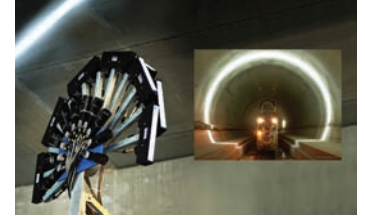

Target Distance (inches)	12	24	36	48	60	72
Line Width (inches)	.55	.7	1	1.2	1.5	1.8

Target Distance (cm)	30	61	91	122	152	183
Line Width (cm)	1.4	1.8	2.5	3.0	3.8	4.6

### Custom beam width available upon request

- Nonwovens
- Fabrics
- Solar Cells
- Hot Steel Inspection
- Long Working distance applications such as tunnel, rail, or ceiling inspection
- High precision, High accuracy measurement applications
- Machine Vision & Automation
- Robotic Inspection

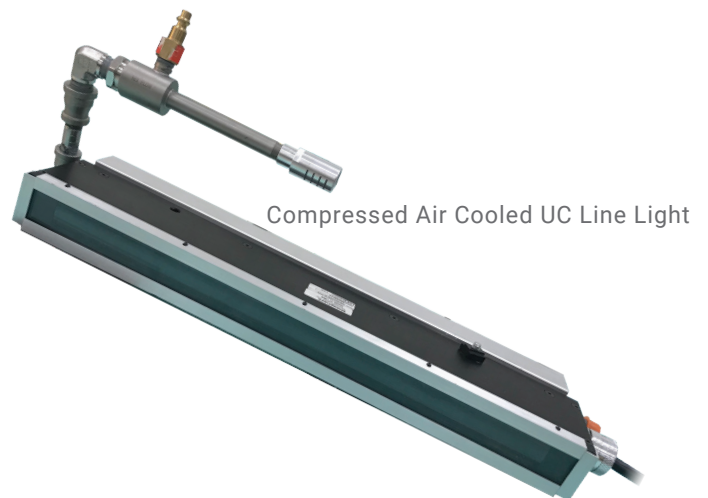

Compressed Air Cooled UC Line Light

# ADVANCED LINE SCAN

## Compact Diffused Tube Line Lights

The Metaphase Compact Diffused Tube Line Lights (CDT) are one of the best kept secrets in Line Scan. They are our diffused tube light with an aperture designed for line scan applications. Its diffused and multi-directional light output makes this light ideal for inspecting highly specular applications. The CDT allows you to see beyond clear plastic and images the product with minimal glare and feedback from the plastic wrap. With its highly diffused light output you can image metallic materials and curved items, such as gel tablets, with minimal glare or hot spotting. The Compact Diffused Tube Line Light is available with a wide variety of LED colors such as White, Red, Green, Blue, IR, UV (365nm & 395nm), and RGB with independent color control up to 80" (2m) in length for large web applications.

### Applications:

- Highly specular applications
- Metallic materials such as aluminum, brass, copper, steel & stainless steel
- Curved objects like gel tablets, bearings, cylinder shaped items
- Machine Vision & Automation
- Robotic Inspection

## Diffused Axial Line Lights

Using beam-splitter technology, Metaphase's Diffused Axial Line Light (DALL) produces co-axial illumination in parallel with the camera aperture. This nonintrusive light provides uniform and extreme intensity for illumination of specular surfaces, reducing glare and hot spots. The DALL can be configured for both wide and narrow fields of view and is the perfect solution to varying height scenarios.

### Applications:

- Cylindrical items inspection for surface flaws
- Defect detection in glass/plastic containers
- Bottle inspection
- CD/DVD label inspection
- Screw/Bolt thread inspection
- Glass sheet inspection
- Inspection of LCD displays; medical and automotive components etc.
- Machine Vision & Automation
- Robotic Inspection

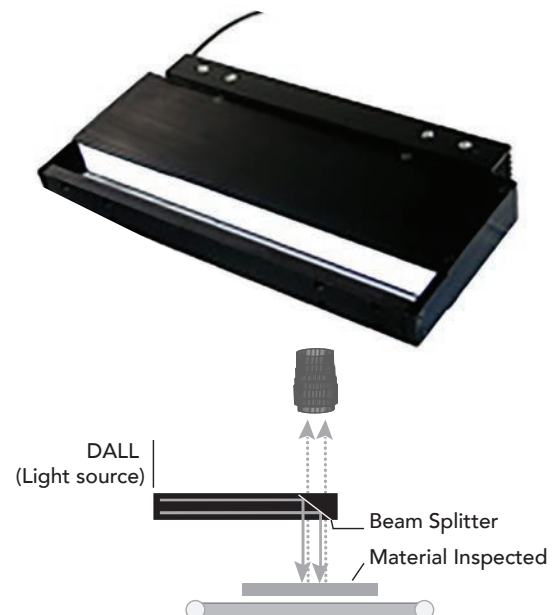
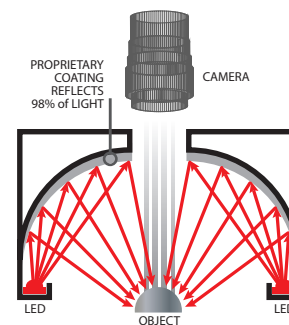
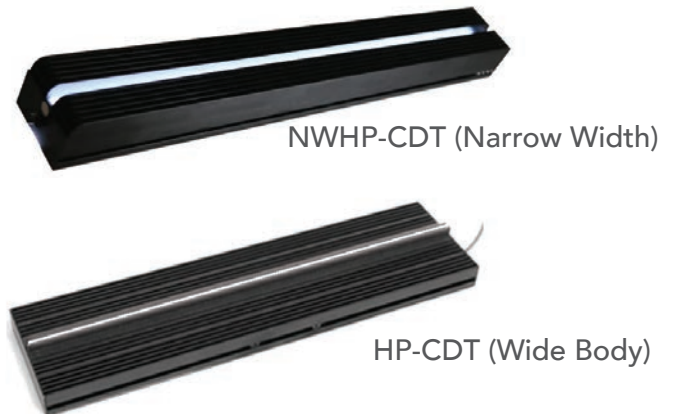

# ADVANCED LINE SCAN

## Oblique (Dark Field) Line Lights

Metaphase's Oblique Line Light (Wrinkle Light) is designed with unique angled LEDs to project light at a 20 degree angle. The angled light makes the OLL great for creating a dark field/off-axis effect for line scan and area scan applications or for wrinkle detection. Using high output LED technology, the Oblique Line light produces high intensity lighting needed for high speed imaging. The Oblique (Dark Field) Line Light is available with a wide variety of LED colors such as White, Red, Green, Blue, IR, UV (365nm & 395nm), and RGB with independent color control.

### Applications:

- For line scan and narrow for area scan applications
- Wrinkle detection
- Dark field
- Cross machine direction
- Fabric inspection
- Coil rolls
- Machine Vision & Automation
- Robotic Inspection

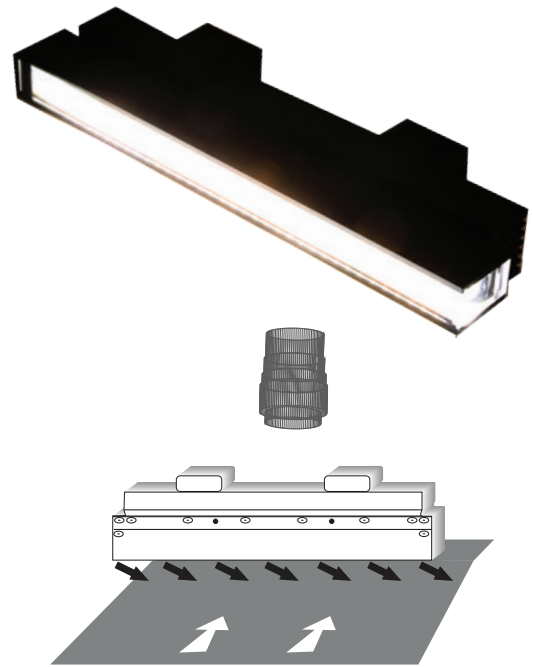

## The Eclipser™ - Dark Field Backlights

This patent-pending dark field line light has never before been offered to the industry. Combining strategically positioned LEDs on innovative dark strips and newly developed light ray forming optics allows discovery of previously overlooked flaws in optically clear glass and plastic. "Bending" light encircles particles and air pockets creating a glow and illuminating the imperfection that can now be seen on a sub-pixel level. The Eclipser™ - Dark Field Backlight is available with a wide variety of LED colors such as White, Red, Green, Blue, IR, UV (365nm & 395nm), and RGB with independent color control up to 120" (3m) in length for large web applications.

### Applications:

- Extruded glass tubing
- Optical lenses
- Extruded and injection molded plastic
- Plate glass
- Machine Vision & Automation
- Robotic Inspection

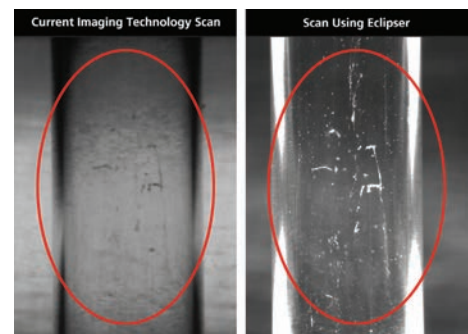
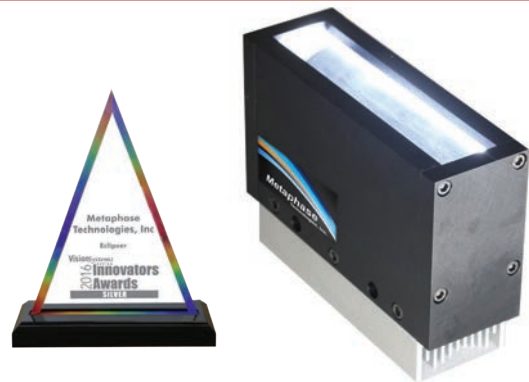
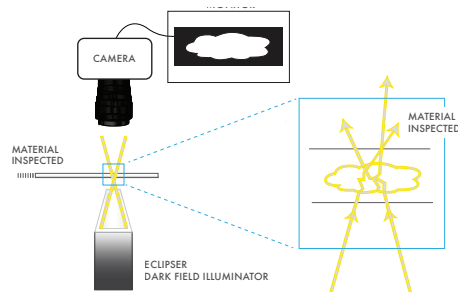

# AREA SCAN

FOR AREA ILLUMINATION

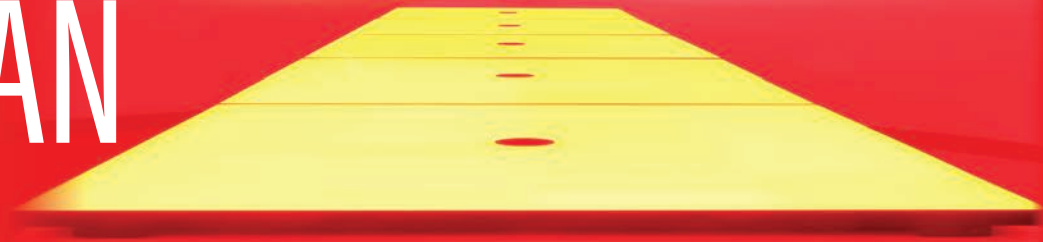

## HIGH INTENSITY & UNIFORMITY

### Why Area Lights?

A robust area scan machine vision system utilizes local illumination as opposed to relying on ambient lighting. As the name implies, area scan illumination covers an x,y area being viewed by the matrix camera (unlike line scan illumination which covers a thin line being viewed by the single pixel row line scan camera.) Like all machine vision applications, the objective is to maximize the contrast between the features of interest and the background. Depending on the object or scene, different illumination techniques are utilized. For applications where the object's movement speed requires a very short, high intensity illumination in order to obtain a crisp, non-blurred image, the illumination is strobed with power-boosting (overdriving).

### Area Scan Lighting Techniques

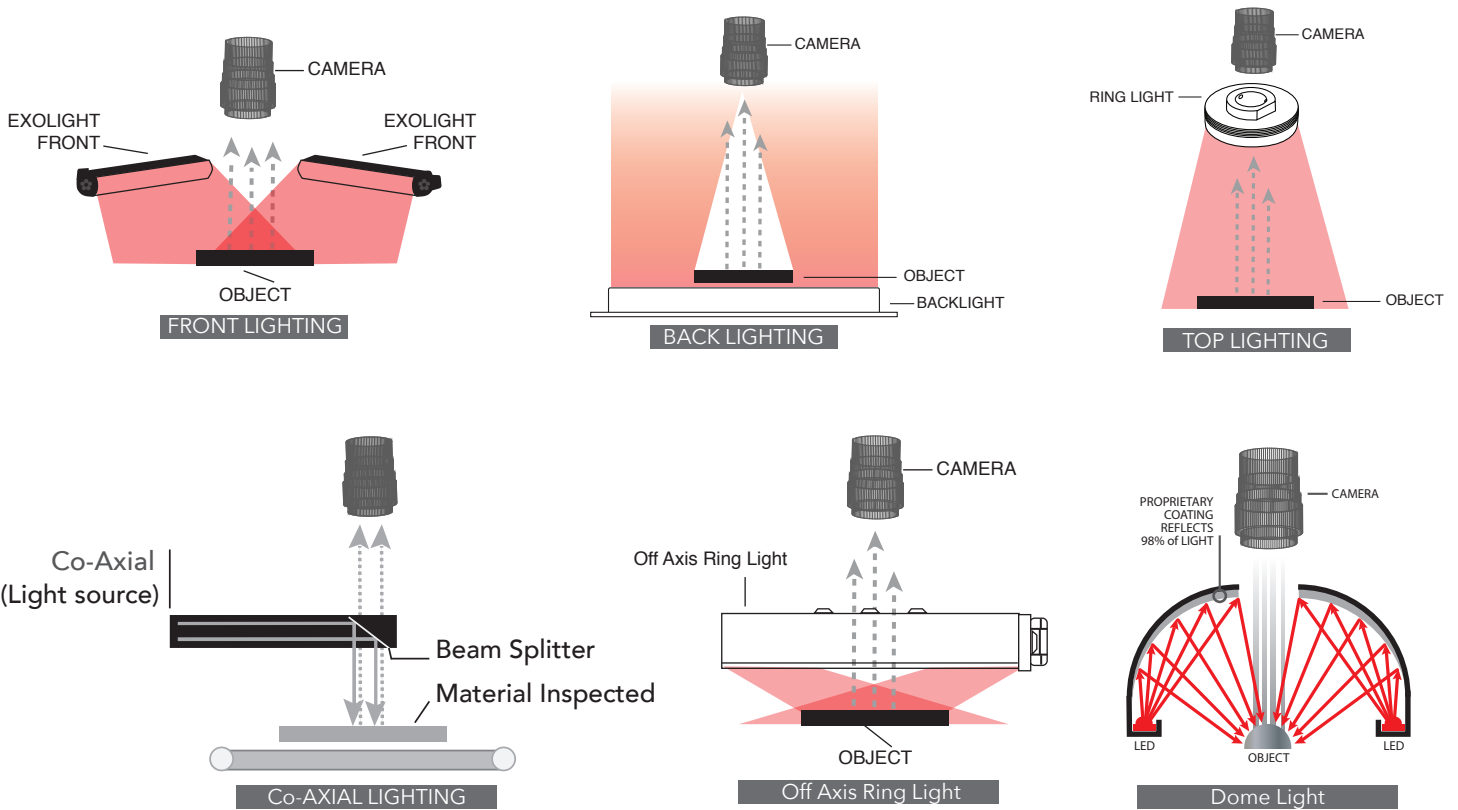



# EXOLIGHT™ SERIES

## HIGH PERFORMANCE LINEAR BAR LIGHTS



### Exolight v2.0 Yes its LED!!!

The 2nd generation Exolight™ builds upon the world-renowned, groundbreaking technology of the original Exolight Series. Our new molded Lumiform diffuser provides a dramatic increase in uniformity, coverage area, and resistance to impact. With a 120° spread of uniform lighting, the EXO2 is perfect for even the most sensitive area scan application and its high level of diffusion makes it a great candidate for transmission or backlight applications; even for line scan. Hard molding makes the diffuser extremely durable to impact and can be configured for an IP rating with greater water and dust resistance.

### Applications:

- Machine Vision & Automation
- Packaging inspection for absence and presence of product
- Work bench illumination
- Automotive component inspection
- Coiled steel pin-hole detection
- Pick & place
- Sorting facilities / Bar code reading
- Robotic Inspection

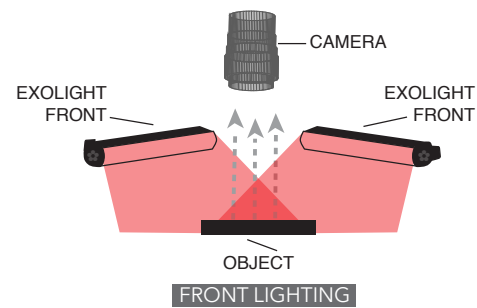
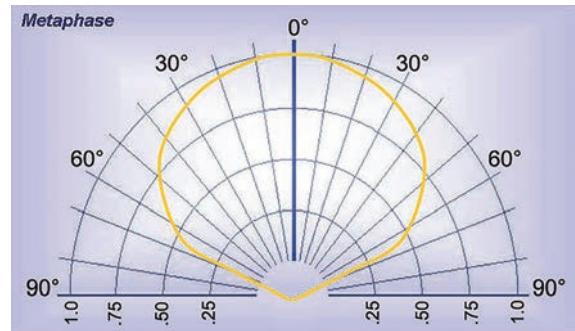

### Exolight™ (Fluorescent Replacements)

The Metaphase Exolight™ is the most efficient and economical LED replacement technology available for the fluorescent tube. The Metaphase Exolight™ is best applied where a highly intense, yet widely diffused light beam is required. Metaphase's own patent-pending isotropic plastic micro-lens diffusers shape the isotropic illumination unique to the ExoLight™. Isotropic lensing produces extremely even illumination and minimizes specular reflection (hot spots/glare) inherent with LEDs. The Exolight™ is "tube-like" in form and mimics the softly diffused output of fluorescent fixtures like no other ordinarily diffused LED fixture can.

### Applications:

- Machine Vision & Automation
- Packaging inspection such as absence & presence of product
- Work bench illumination
- Automotive component inspection
- Coiled steel pin-hole detection
- Pick & Place applications
- Sorting facilities
- Robotic Inspection

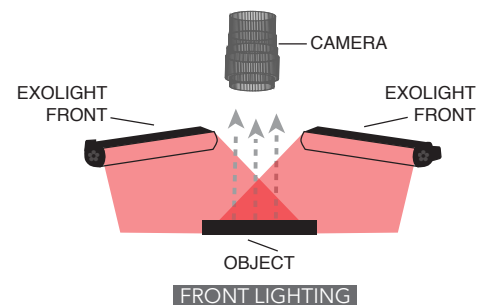

# DOMES ILLUMINATION

## Flat Dome/Omni Lights

The new MetaBright™ OmniLight flat dome from Metaphase combines the best of our MetaBright™ technology with the enhanced and ultra-uniform lighting output of our newest TIR diffuser. Our lightweight alloy housing comes with welded brackets for secure and easy mounting. These lights are ideal when you need a diffused light source for close up inspection but can't fit in a traditional dome light.

### Applications:

- Application requiring light and camera to be on-axis and/or the products height varies
- High Speed bar code reading
- PCB inspection

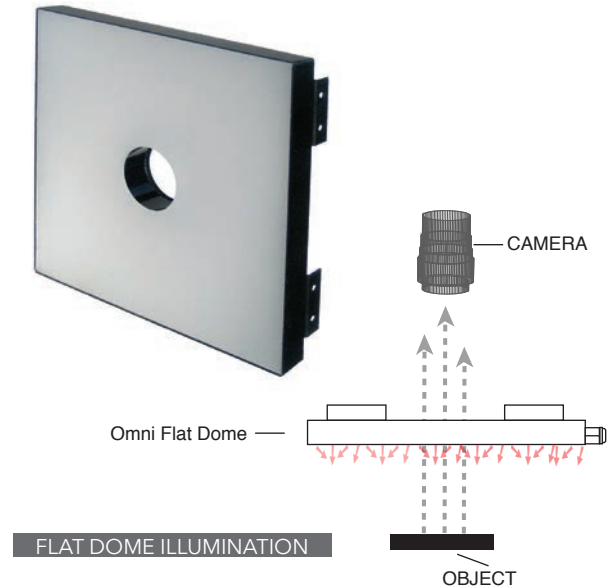

## Diffused Dome & Tube Lights

These special illuminators provide intense, evenly diffused illumination. The Diffused Dome Light is ideal for inspection of reflective, specular, rough or topographic surfaces. Optical grade reflector coating returns 99.9% of light for optimum diffused output. Current dome lights range in size from 1.4 inches (36mm) to 44 inches (1106mm) ID. The Diffused Dome Light is available with a wide variety of LED colors such as white, red, green, blue, IR, UV (365nm and 395nm), and RGB.

### Applications:

- Application requiring light and camera to be on-axis and/or the products height varies
- High Speed bar code reading
- PCB inspection

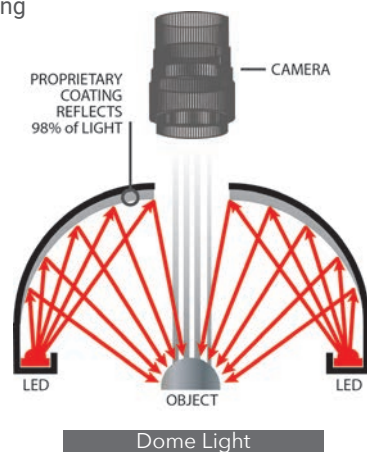

# DOMI ILLUMINATION

## Co-Axial Dome Lights

For highly reflective and precise applications, the Dome Light can create a dark spot in the image due to lack of light reflecting down from the camera viewing port. For these types of applications, adding our DAL (Co-Axial Light) on top of the dome eliminates this gap and the dark spot. The Metaphase CODL (Co-Axial & Dome Light) conveniently packages the units together to make integration of the DAL with the Dome Light simple and easy.

### Applications:

- Application requiring light and camera to on-axis and/or the products height varies.
- High-speed bar reading
- PCB inspection
- Machine Vision & Automation
- Robotic Inspection

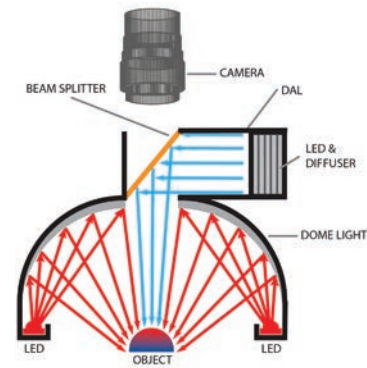
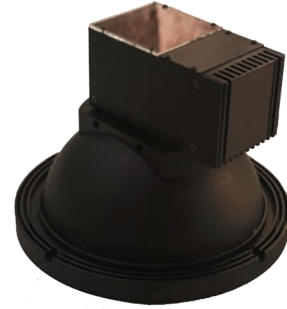

## Diffused Axial Lights

Metaphase Diffused Axial Lights use beam-splitter technology to radiate homogeneous, coaxial illumination in line with the camera aperture. Diffused coaxial lighting eliminates dark spots or shadows inherent in other forms of illumination and allows the camera to be placed at a longer working distance. Equipped with multiple tapped holes for mounting, the MB-DAL can be easily integrated into existing vision systems. An advanced thermal management system ensures a long lifetime and cost effectiveness. Various wavelengths including red, green, blue, white, IR, UV and RGB are available. The MB-DAL is also available with strobe and dimming options.

### Applications:

- Sphere inspection for surface flaws
- Defect detection in glass/plastic containers
- Ball-Bearing inspection
- CD/DVD label inspection
- Bottle cap inspection
- Screw/Bolt thread inspection
- Inspection of LCD displays; medical and automotive components etc.
- Ideal for reflective/shiny surfaces

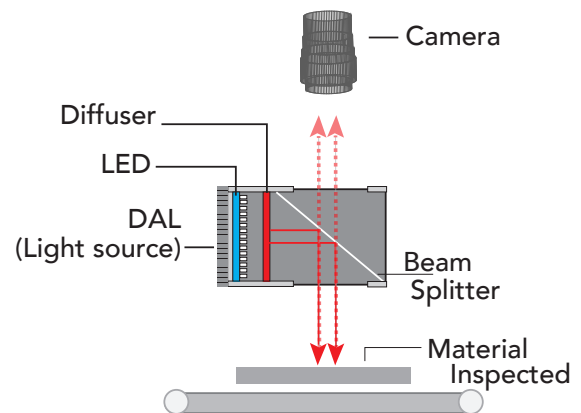

# RING LIGHTS

## MetaBright™ Ring Light

The Metaphase near axial Ring Lights offer high intensity, shadow-less illumination with five times the lifetime over fluorescents. Ring lights are essential for lighting specular surfaces. The MetaBright™ near axial Ring Lights are built with high density LEDs that create bright illumination of surfaces for a wide variety of inspection applications. Metaphase Ring Lights are specially designed to project an even 360° overlapping ring of light from camera to lens. In most front lighting applications, the near axial Ring Light is a simple, low cost solution to camera lighting.

### Applications:

- Label Identification
- Direct part marking identification
- Surface inspection and finishes
- Microscopic stage illumination
- Solder joint inspection
- Components identification
- Molded part features
- Close-up, near-shadowless single light illumination applications
- Machine Vision & Automation
- Robotic Inspection

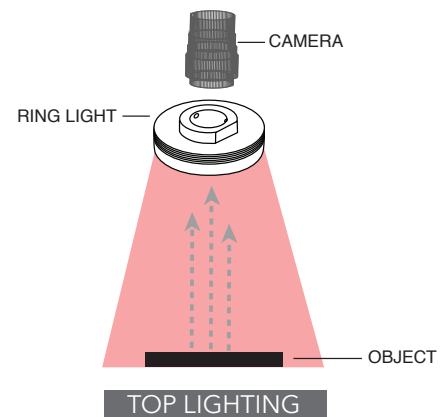

## Off Axis Ring Light (OARL)

Off-Axis Ring Lights provide a low angle plane of light which is useful for highlighting surface defects, illuminating specular surfaces, and side-lighting prominent target features. Dark field illumination provides high contrast lighting for detecting stress, defects, fingerprints, edges, dust etc. When the dark field light is placed above an object, intense light will appear at the edges and imperfections will be accentuated in a high-contrast manner.

### Applications:

- Surface defects such as raises or digs
- For Highlighting edges or raised edges of parts
- Robotic Inspection
- Machine Vision & Automation

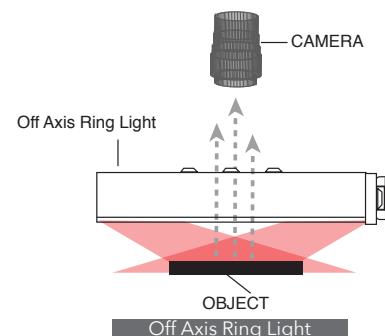



# WASHDOWN & HARSH ENVIRONMENT

## Robolight

MetaBright™ Robolights provide high intensity direct illumination comparable to MetaBright™ Front Lights and are designed for IP68 rated environments with an optional IP69K version available for all model sizes. Robolights feature rugged industrial housings for industrial work envelopes. The Robolight is a cost effective and “integrator ready” machine vision illuminator with an integrated constant current driver that includes 0-10V intensity control.

### Applications:

- Large Work envelopes
- Packaging, food and pharmaceuticals
- Liquid filling inspection
- Geometry measurements of long targets
- Harsh environments
- Washdown applications
- IP69K version available
- Machine Vision & Automation
- Robotic Inspection



## Washdown Ring Light

The Washdown Ring Light allows the use of one of the most popular lighting systems in a larger variety of environments and can be used where they may be exposed to water, moisture, and debris. With the IP67 rated watertight gasket design, low-pressure jets and washdowns are not a problem; great for food and drug inspections or outdoor applications. Three ¼-20 tapped holes provide the ability to mount the ring light directly to the camera. This light is available in aluminum or stainless-steel.

### Applications:

- Electronic and circuitry inspecting
- Robotic vision and Automation
- Pick and Place Machines
- Bar Code Reading
- Food
- Drug
- Medical
- Outdoor

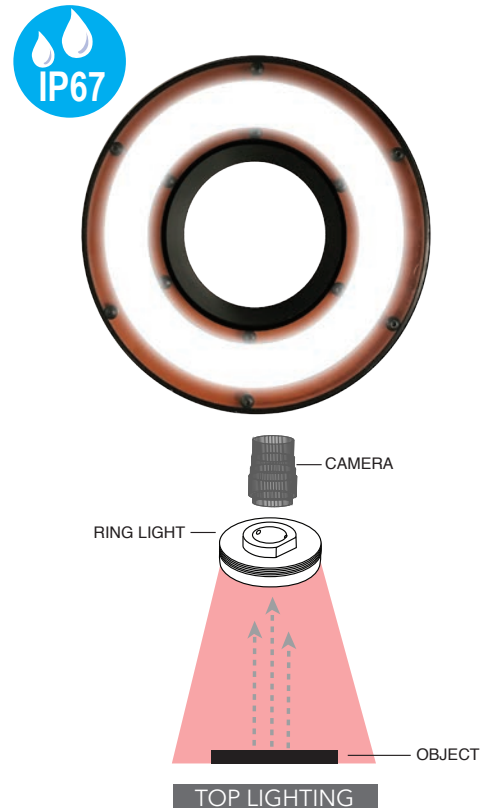

# WASHDOWN & HARSH ENVIRONMENT

## Washdown Off-Axis Ring Light (OARL)

The Metaphase Washdown Off-Axis Ring light (OARL) takes our proven Off-Axis ring light and puts it into a washdown and harsh environment configuration. Our washdown OARL can now be used where they may be exposed to water, moisture, and debris. With this watertight gasket design, high-pressure jets and washdowns are no problem; great for food, drug, or outdoor applications. The off-axis ring light (dark field) provides a near horizontal plane of light which is useful for highlighting surface defects, illuminating specular surfaces, and side lighting prominent target features. Our ring lights can be configured for wavelength and other specifications.

### Applications:

- Surface defects such as raises or digs
- For Highlighting edges or raised edges of parts
- Machine Vision & Automation
- Robotic Inspection

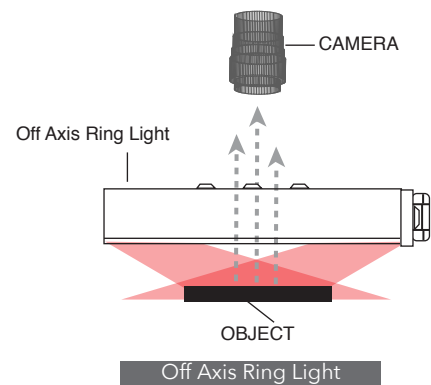
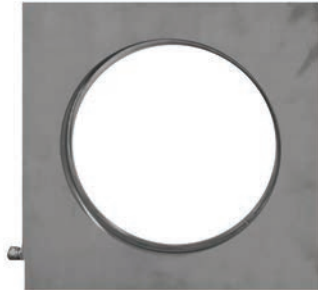

## Washdown Spotlights

Unlike fluorescent spotlights, these LED illuminators have a long lifetime and will not degrade over time. These efficient lights consume only 11 watts of power and are six times brighter than a 60-watt incandescent. Metaphase's LED spotlight provides low cost, washdown illumination. These illuminators are available in a variety of beam angles and optimal working distances and are encased in a rugged waterproof housing that can stand up to high pressure washdown environments. The standard spotlight has a  $\pm 16^\circ$  (Medium) beam angle (i.e. 1.1m coverage at 4.0m working distance). Other beam angles include  $\pm 12^\circ$  (Narrow) and  $\pm 25^\circ$  (Wide).

### Applications:

- Spot Lighting
- Washdown Applications
- Machine Vision & Automation
- Robotic Inspection





## Washdown Area Front Light 300x150

The Washdown Area Front light provides direct intense light in an IP68 rated enclosure. The design has been ruggedized to protect against shock and vibration. Used alone or in pairs, these lights have the advantage of being able to be moved to both On and Off axes to provide the best illumination scenario in any indoor/outdoor application.

### Applications:

- Enclosures with NEMA and IP ratings
- Lights made with FDA approved washdown compatible materials
- Dust and water tight enclosures
- Explosion proof lighting
- Outdoor or corrosion proof enclosures
- Food and Drug lighting
- Military lighting



## Washdown Backlight 300x150

The Washdown Backlight is a high performance and uniform light source for silhouetting and transmissive applications. These IP68 Washdown Backlights can be used where they may be exposed to water, moisture, and debris. With the watertight gasket design, high-pressure jets and washdowns are no problem; great for food, drug, or outdoor applications. Using a full array LED layout, we can pack more LEDs per square inch to provide greater intensity, uniformity, and performance.

### Applications:

- Silhouette
- Transmissive Imaging
- Washdown
- Food
- Medical

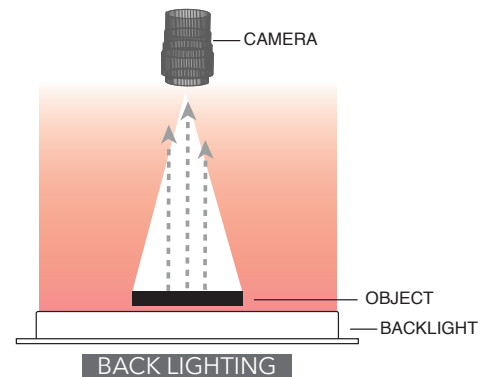

# BACKLIGHTS

## MetaBright™ Backlights

The Metabright™ series Area Backlight is a high performance and uniform light source for silhouetting and transmissive applications. Using a Full Array LED layout, we can pack more LEDs per square inch to provide greater intensity, uniformity and performance. The Metabright™ Area Backlight Series is available with a wide variety of LED colors and sizes including White, Red, Green, Blue, IR, UVS, UVL and RGB with independent color control and with active areas ranging from 1"x1" (25mm x 25mm) to custom order sizes of 5' x 5' (1.5m x 1.5m).



## MetaBright™ Thin Backlights

The Thin Backlight Series is a high performance and uniform light source for silhouetting and transmissive applications. With a housing thickness of less than 11mm and edge-to-edge lighting, the thin backlight series helps maximize illumination area in tight spaces. Using a Full Array LED layout, we can pack more LEDs per square inch to provide greater intensity, uniformity and performance. The Thin Backlight Series is available with a wide variety of LED colors and sizes including White, Red, Green, Blue, IR, UVS and UVL with active areas ranging from 1"x1" (25mm x 25mm) to 5"x10" (127mm x 254mm).

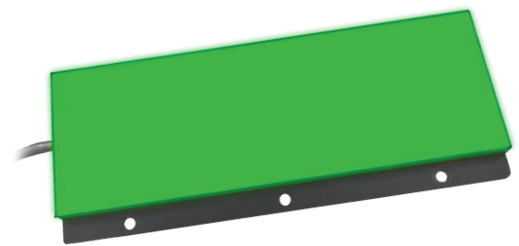

## Applications:

- High precision measurements and telecentric applications
- Absence/presence of objects
- Defect detection in glass/plastic containers
- Object tracking (fish in aquarium)
- PCB (printed circuit board) assembly through-hole lead detection
- Web inspection (pin-holes in web)
- Bottle cap inspection
- Screw/bolt thread inspection
- Glass sheet defect detection
- Sub-pixel dimensional inspection

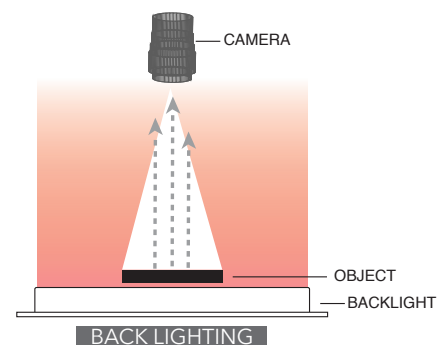



## Economical Backlights

Economical Backlights combine the latest super bright LEDs with Metaphase's laser-edged Lumiform technology to produce highly uniform ( $\pm 5$  to  $\pm 10\%$ ) illumination. This breakthrough in light-guiding diffusion makes this one of Metaphase's most affordable models.



## MetaStandard Backlights

Our line of MetaStandard Backlights provides a more economical option to our lineup of MetaBright Backlights for applications requiring large active areas for silhouetting or transmissive applications. Utilizing a Full Array LED layout provides better uniformity and intensity compared to large sized edge lit backlights. Using Metaphase analog driver technology you will get flicker-free performance and dimming control. With 30,000 Lux of Intensity and  $\pm 10\%$  uniformity, the Metastandard Backlight is a leader in price and performance.



## Collimated Tube Backlights

Metaphase Technologies Collimated Tube Backlights are ideal for producing high contrast silhouettes. The Collimated Tube Backlight boasts increased illumination compared to standard backlights when used with telecentric lensing. Telecentric illumination is ideal for precision measurements where accuracy, repeatability, and throughput are key factors in the application's success.



## Collimated Backlights

The Collimated Backlight Series is a high performance, uniform, and collimated light source for high precision silhouetting and transmissive applications. Using precision optics, the light is collimated in both the X and Y dimensions. The light exits at a low divergence angle making it perfect for applications requiring high precision measurements when used with a telecentric lens. These lights utilize a full array LED layout with more LEDs per square inch to provide greater intensity and uniformity.



# LED LIGHT ENGINES & FIBER ILLUMINATION

## Metaphaser LED Light Engine

This system is ideal for replacing older generation “hot light” fiber based illuminator systems and for green technology efficiency upgrade programs. Designed for fiber optics with light acceptance areas of 6 - 20mm. With appropriate Metaphase adapter, can mechanically accept fiber optics with outer housing diameters up to 20mm.

### Applications:

- Microscopy
- Industrial Borescopes
- Inspection Systems
- Machine Vision



## MP-LED-150

The Metaphase Fiber Optic LED Illuminator provides intense illumination for fiber optic delivery systems. The Metaphase Fiber Optic LED Illuminator includes various nose pieces for mating the fiber light guide to the supply. Nose pieces include a Universal nose piece with optional adapters to mate to a wide variety of fiber tip diameters and individual nose pieces that are designed for specific fibers.

### Applications:

- Microscopy
- Endoscopy
- Spotlight source
- Fiber Backlighting
- Architectural Fiber Lighting
- Machine Vision
- Fiber line Lig



## LED Light Engine

Designed as a small, compact LED light engine for fiber optics as well as lenses with coaxial 8mm light port (“through-the-lens lighting”). This light source features patent-pending optical and thermal control technology. Available with various wavelengths including UV & IR. Versions include an internal 24V constant current driver as well versions for external constant current/strobe controllers such as the Metaphase ULC.

### Applications:

- Machine Vision & Automation
- Robotic Inspection
- Microscopy



# LED CONTROLLERS & DRIVERS

## ULC-2 Universal LED Controller (ULC)

Metaphase Technologies' Universal LED Controller provides independent, constant-current control of two LED loads at up to 4amps continuous DC and a maximum output power of 60 Watts per channel. In Pulse (Strobe) Mode, the ULC-2 is capable of output currents up to 40 amps. The ULC-2 is capable of driving LED forward voltages between 3V and 20V and higher, but with a possible reduction in maximum pulse current. Pulsewidths are adjustable down to 2 microseconds and external trigger rates up to 50kHz.



### Applications:

This unit is a comprehensive control device built for compatibility with standard LED illumination systems. For use in continuous intensity mode or strobing control with programmability for trigger delay, and pulse variation via user-friendly LCD interface or using Ethernet and USB commands.

## DDC-3 Digital Dimming Controller - 3 Channels

Metaphase Technologies' Digital Dimming Controller (DDC-3) provides 0-10VDC dimming control for three independent LED loads in increments of 0.1V. The DDC-3 may be remotely controlled over Ethernet using Metaphase Technologies' MetaBOSS Windows software or by third-party programs using the DDC-3's Ethernet Commands. Additionally, user-adjustments of the DDC-3 are provided by way of a user-friendly LCD interface.



### Applications:

- Machine Vision & Automation Systems
- Robotic Inspection

## LC2-PWM20 Pulsewidth Modulated Controller

The LC2-PWM20 is a dual channel, pulsewidth modulated LED intensity controller. It outputs 12V PWM from 0-100% at 100kHz to drive LED loads with series limiting resistors. The maximum output is 20W per channel and 30W combined for two channels. Power is limited by the 24V power supply.



# STROBE LIGHTS

## Law Enforcement Light & Long Range Strobe Lights

Designed to replace high power xenon strobes, this affordable LED strobe light can project a beam of light to over 150 feet to illuminate a small target. The Law Enforcement Light features a weather proof enclosure. Strobe pulse widths are adjustable from  $2\mu\text{s}$  to  $250\mu\text{s}$  with pulse rates up to 50kHz. Strobe controls include intensity, strobe rate, trigger delay etc. Integrated mounting hardware is included to assist with installation in virtually any environment.

### Applications:

- Law Enforcement
- Automatic Number Plate Recognition
- Stop Motion Video
- High Speed Photography
- Night Vision Surveillance



## Border Patrol Light

The Metaphase Border Patrol Light is a customized version of our Law Enforcement Light. The BPL is designed with many features for surveillance and security checkpoint monitoring. The BPL has two separate LED arrays that can be selected with different color LEDs including Infrared. The Border Patrol Light features a weather proof enclosure with optional powder coated hood. Other features include adjustable beam angles of one or both LED sections. Strobe pulse widths are adjustable from  $2\mu\text{s}$  to  $250\mu\text{s}$  with pulse rates up to 50kHz.

### Applications:

- Surveillance and Security checkpoint control monitoring
- Border Patrol
- Law Enforcement
- High Speed Photography
- Night Vision Surveillance
- Stop Motion Video
- Automatic Number Plate Recognition



## Explosive & Military Application

Metaphase lighting is used in many military projects; often integrated into explosion-proof enclosures for volatile applications. For example, a hot-running inspection unit could ignite fumes during a gas tank inspection which are especially prevalent in the military. LED technology is perfect for this type of application because of its low heat output.





# PROJECTION LIGHTS

## Round Area Front Lights (Spot Light)

This RAL light provides direct intensity lighting. Used alone or in pairs these lights have the advantage of being able to be moved around to both on and off axis to provide the best lighting scenario. Our front lights can be configured for wavelength and other specifications.

### Applications:

- Machine Vision & Automation
- Robotic Inspection



## LED Pattern Projector (LPP)

The LED Pattern projector projects a variety of patterns at different working distances. Paired with a lens and pattern reticle, the LED pattern projector is ideal for structured light applications. The device intensity can be controlled with a 0-10V intensity control signal. Using 10 watt LED technology, we can push out more intensity without the danger of lase

### Applications:

- Pick and Place
- Micro Defects
- Inspection of Black with low diffusion properties
- High Speed QC
- Small Space Apps

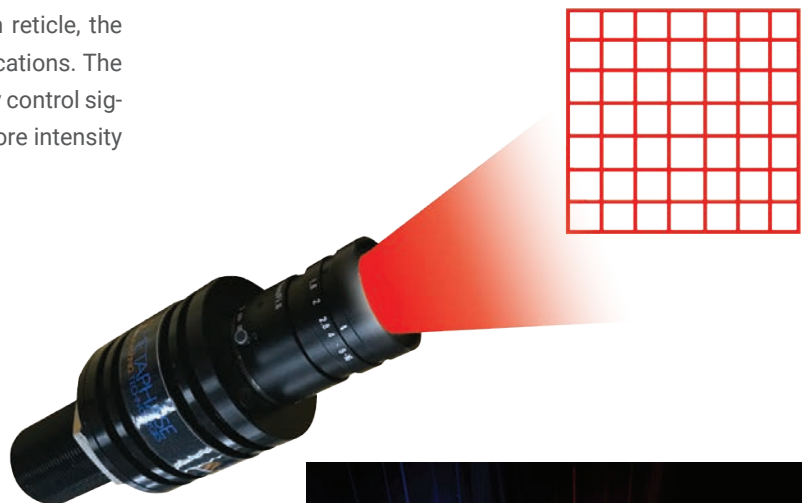

## STANDARD PATTERNS

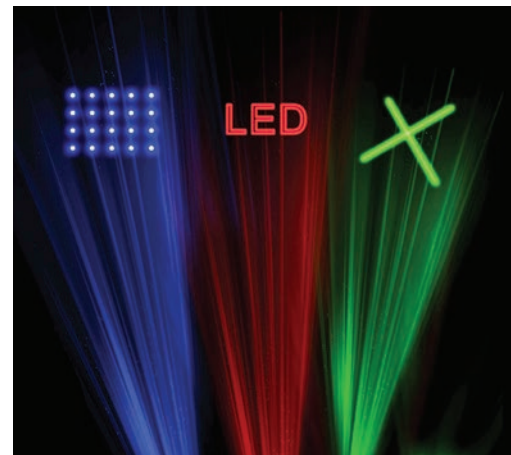
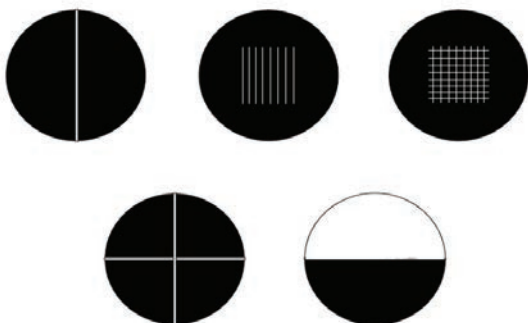

# EXPERT IN ENGINEERING

For nearly two decades, Metaphase Technologies has been developing products that advance “The Quality of Light” through engineering and manufacture of cutting-edge LED illuminators for machine vision, military, and specialty lighting applications. We boast expertise in engineering flexible lighting solutions for ease of integration into vision systems design.



# CUSTOMIZATION

Metaphase Technologies prides itself on its comprehensive optical engineering capabilities and employs a full-time engineering staff of both mechanical and electrical engineers to address all of your lighting problems. Whether your need is for one light or thousands of production units, you can count on the Metaphase team to deliver solid results. Our team will work with you from tissue sketch to assembly line manufacturing. Unlike other off-the-shelf lighting companies, we welcome the opportunity to review your lighting ideas and help you design a revolutionary lighting product. As manufacturers, our designs will always have emphasis on quality and cost effectiveness. Please contact your sales representative to learn more.

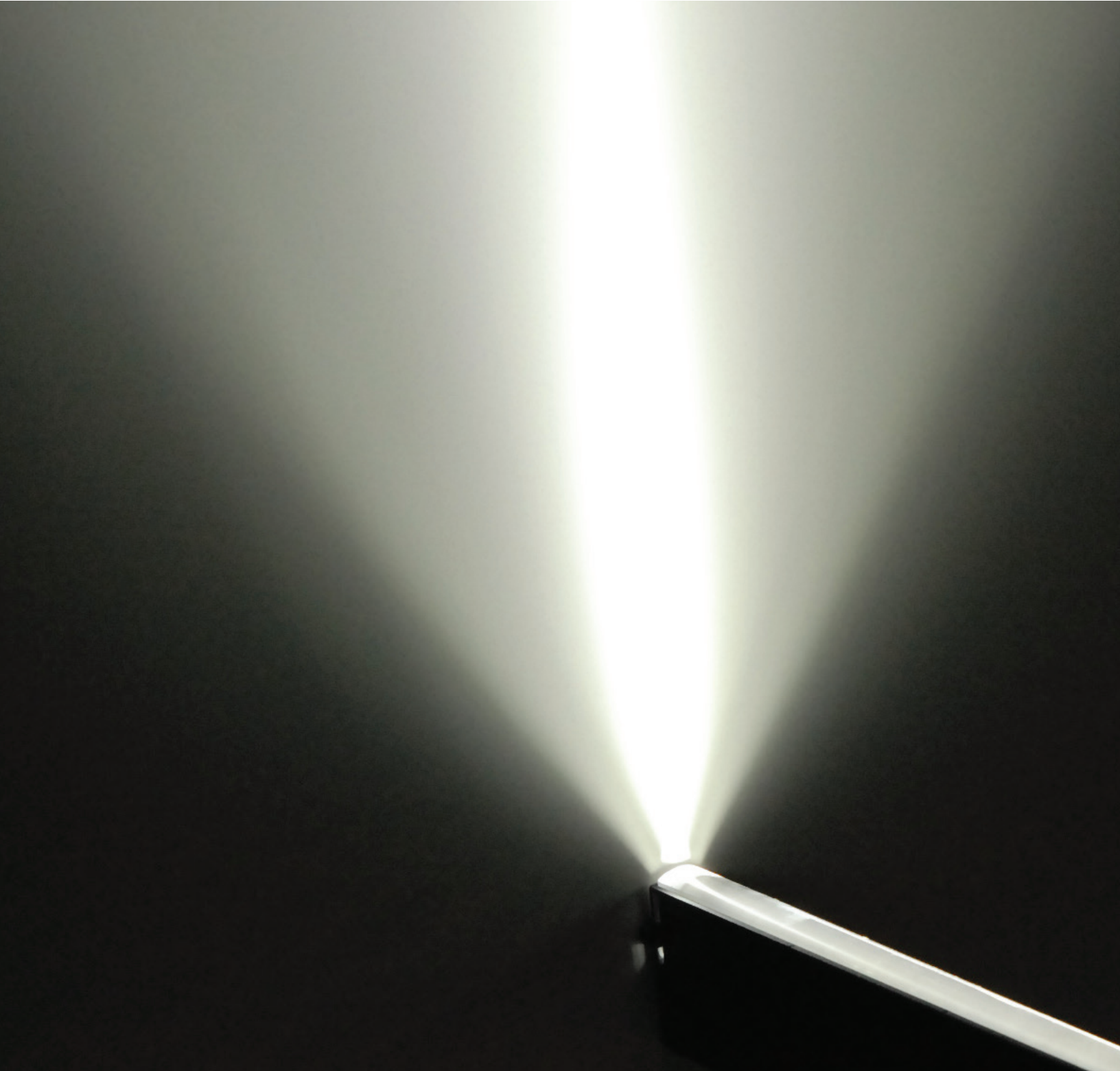



Products Designed and Built Exclusively In The USA



211 Sinclair Road Suite 100, Bristol, PA 19007 USA  
Tel: 215-639-8699 • Fax: 215-639-0977  
[www.metaphase-tech.com](http://www.metaphase-tech.com)